

User Guide  
6623-2201

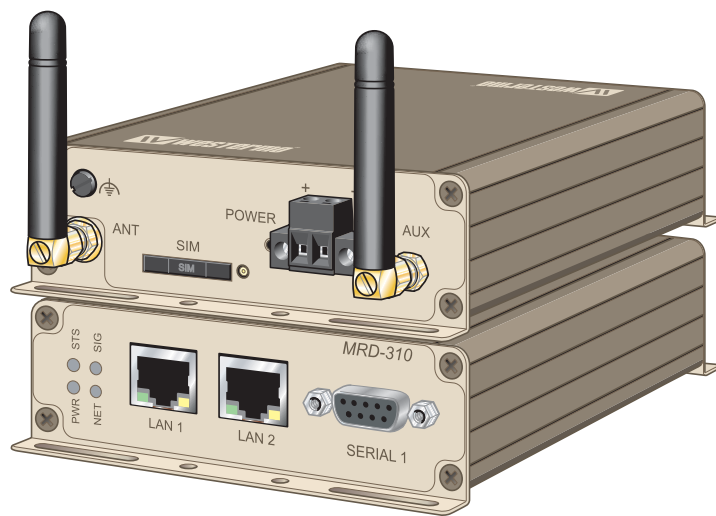

# MRD-310



**3G Cellular Modem / Router**

[www.westermo.com](http://www.westermo.com)

## **Legal information**

The contents of this document are provided "as is". Except as required by applicable law, no warranties of any kind, either express or implied, including, but not limited to, the implied warranties of merchantability and fitness for a particular purpose, are made in relation to the accuracy and reliability or contents of this document. Westermo reserves the right to revise this document or withdraw it at any time without prior notice.

Under no circumstances shall Westermo be responsible for any loss of data or income or any special, incidental, and consequential or indirect damages howsoever caused.

More information about Westermo can be found at the following Internet address:

**<http://www.westermo.com>**

## Safety



### **Before using this unit:**

Read this manual completely and gather all information on the unit. Make sure that you understand it fully. Check that your application does not exceed the safe operating specifications for this unit.

Hazardous voltages may occur within this unit when connected to a power supply. Prevent access to hazardous voltages by disconnecting the unit from its power supply.

Prevent damage to internal electronics from electrostatic discharges (ESD) by discharging your body to a grounding point (e.g. use of wrist strap).



### **Before installation:**

This unit should only be installed by qualified personnel.

This unit should be built-in to an apparatus cabinet, or similar, where access is restricted to service personnel only.

The power supply wiring must be sufficiently fused, and if necessary it must be possible to disconnect manually from the power supply. Ensure compliance to national installation regulations.

This unit uses convection cooling. To avoid obstructing the airflow around the unit, follow the spacing recommendations (see Installation section).

## Care recommendations

Follow the care recommendations below to maintain full operation of unit and to fulfil the warranty obligations.

This unit must not be operated with covers or lids removed.

Do not attempt to disassemble the unit. There are no user serviceable parts inside.

Do not drop, knock or shake the unit, rough handling beyond the specification may cause damage to internal circuit boards.

Do not use harsh chemicals, cleaning solvents or strong detergents to clean the unit.

Do not paint the unit. Paint can clog the unit and prevent proper operation.

Do not expose the unit to any kind of liquids (rain, beverages, etc). The unit is not waterproof. Keep the unit within the specified humidity levels.

Do not use or store the unit in dusty, dirty areas, connectors as well as other mechanical part may be damaged.

If the unit is not working properly, contact the place of purchase, nearest Westermo distributor office or Westermo Tech support.

## GSM specific safety

Please read and follow the guidelines listed below. The precautions must be observed during all phases of the operation. Breaking these rules may be dangerous, illegal or affect performance of the unit and/or invalidate the unit's approval and/or warranty.

## **General**

Remember to follow any special regulations and warnings in force in any area and never use the unit whenever it is forbidden to use it. Do not use the unit when it may cause interference or danger. A wireless device exposed to interference above specified limits could result in deteriorated performance.

## **Hospitals or other Medical environment**

Do not use the unit in a medical environment such as health care facilities. Follow any regulations or rules that instruct you to not use the unit.

### *Pacemakers*

The Health Industry Manufacturers Association recommends that a minimum separation of six (6") inches be maintained between cellular wireless equipment and a pacemaker to avoid potential interference with the pacemaker. These recommendations are consistent with the independent research by and recommendations of Wireless Technology Research.

Persons with pacemakers:

- ⚡ Should ALWAYS keep the the unit and its antenna more than six inches from their pacemaker when the unit is turned ON.
- ⚡ If you have any reason to suspect that interference is taking place, turn your wireless equipment OFF immediately.

### *Hearing Aids*

Some digital wireless equipment may interfere with some hearing aids. In the event of such interference, you may want to consult your service provider [or call the customer service line to discuss alternatives.]

### *Other Medical Devices*

If you use any other personal medical device, consult the manufacturer of your device to determine if they are adequately shielded from external RF energy. Your physician may be able to assist you in obtaining this information.

Turn the wireless equipment OFF in health care facilities when any regulations posted in these areas instruct you to do so. Hospitals or health care facilities may be using equipment that could be sensitive to external RF energy.

## **Aircraft**

Do not use the unit in an aircraft. The use of a wireless unit in an aircraft may be dangerous to the operation of the aircraft, disrupt the wireless network, and may be illegal.

Failure to observe these instructions may lead to suspension or denial of cellular services to the offender, legal action, or both.

## **Vehicle**

If the unit is incorrectly installed in a vehicular environment, the operation of the unit could interfere with the vehicle electronics. Faulty installation and/or operation can constitute a safety hazard.

## **For Vehicles equipped with an airbag**

An air bag inflates with great force. DO NOT place objects, including either installed or portable wireless equipment, in the area over the air bag or in the air bag deployment area. If in-vehicle wireless equipment is improperly installed and the air bag inflates, serious injury could result.

## **Blasting areas**

Do not use the unit where blasting is in progress or in "blasting areas". Observe restrictions and follow any regulation or rules.

## **Explosive atmospheres**

Do not use the unit in any area with a potentially explosive atmosphere.

Potentially explosive areas are often, but not always, clearly marked.

They include fuelling areas such as petrol stations, below decks on boats, fuel or chemical transfer or storage facilities, and areas where the air contains chemicals or particles, such as grain, dust, or metal powder.

## **RF energy**

The unit is a low power radio transmitter and receiver. When it is ON, it receives and also sends out radio frequency (RF) signals.

Most modern electronic equipment is shielded from RF signals. However, certain electronic equipment may not be shielded against the RF signals from the wireless unit. All radio-transmitting devices send signals, which may cause interference in different electronic devices. To avoid interference, place the unit's antenna a sufficiently long distance from other electronics.

## **Critical applications**

Cellular units operate using radio signals and cellular networks cannot be guaranteed to connect in all conditions. Therefore you should never rely solely on a wireless device for essential communications, for example medical emergencies.

## **Backup copies**

Remember to make backup copies of all important data, for example PIN/PUK codes, contents of SIM card etc.

## **Antenna care**

Use only the supplied or an approved replacement antenna. Unauthorized antennas, modifications, or attachments could damage the unit and may violate current regulations.

Do not touch the antenna unnecessarily when the unit is in use. Contact with the antenna affects call quality and may cause the unit to operate at a higher power level than otherwise needed.

## **Maintenance**

No maintenance is required, as long as the unit is used as intended within the specified conditions.

## Agency approvals and standards compliance

Type		Approval / Compliance	
EMC		EN 61000-6-1	Immunity residential environments
		EN 61000-6-2	Immunity industrial environments
		EN 61000-6-3	Emission residential environments
		EN 61000-6-4	Emission industrial environments
Safety		EN 60950	IT equipment
R&TTE	Article 3.1a	EN 60950	Safety
		EN 50385	EMF exposure
	Article 3.1b	EN 301 489-1	ERM/EMC
		EN 301 489-7	ERM/EMC GSM
		EN 301 489-24	ERM/EMC 3G
	Article 3.2	EN 301 908-1	ERM 3G
		EN 301 908-2	ERM 3G
EN 301 511		GSM	

# Declaration of Conformity



Westermo Teleindustri AB

## Declaration of conformity

The manufacturer Westermo Teleindustri AB  
SE-640 40 Stora Sundby, Sweden

Herewith declares that the product(s)

Type of product	Model	Art no
3G router	MRD 310	3623-0001

is in conformity with the following EC directive(s).

No	Short name
1999/5/EC	Radio and Telecommunications Terminal Equipment

References of standards applied for this EC declaration of conformity.

No	Title	Issue
EN 50385	Product standard to demonstrate the compliance of radio base stations and fixed terminal stations for wireless telecommunication systems with the basic restrictions or the reference levels related to human exposure to radio frequency electromagnetic fields (110 MHz - 40 GHz) - General public	1 (2002)
EN 301489-1	ElectroMagnetic compatibility and Radio spectrum Matters (ERM) - ElectroMagnetic Compatibility (EMC) standard for radio equipment and services – Part 1, Part 7, and Part 24	2 (2001)
EN 301489-7		1 (2000)
EN 301489-24		1 (2001)
EN 301511	Global System for Mobile communications (GSM)	1 (2001)
EN 301908-1	Electromagnetic compatibility and Radio spectrum Matters (ERM) - Base Stations (BS) and User Equipment (UE) for IMT-2000 Third-Generation cellular networks – Part 1 and Part 2	1 (2002)
EN 301908-2		1 (2002)
EN 60950-1	Information technology equipment. Safety. General requirements	2 (2006)

The last two digits of the year in which the CE marking was affixed: 08

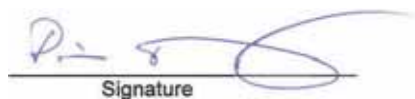

Signature

Pierre Öberg  
Technical Manager  
29th October 2008

---

Postadress/Postal address	Tel.	Telefax	Postgiro	Bankgiro	Org.nr/ Corp. identity number	Registered office
S-640 40 Stora Sundby Sweden	016-428000 Int+46 16428000	016-428001 Int+46 16428001	52 72 79-4	5671-5550	556361-2604	Eskilstuna

## Type tests and environmental conditions

Phenomena	Test	Description	Test levels
ESD	EN 61000-4-2	Enclosure contact	± 4 kV (crit A)
		Enclosure air	± 8 kV (crit A)
RF field AM modulated	IEC 61000-4-3	Enclosure	10 V/m (crit A) (80 – 2700 MHz)
Fast transient	EN 61000-4-4	Signal ports	± 1 kV (crit A)
		Power ports	± 2 kV (crit A)
Surge	EN 61000-4-5	Ethernet ports	± 1 kV (direct) (crit A)
		Power ports	± 0.5 kV (line to earth) (crit A)
			± 0.5 kV (line to line) (crit A)
RF conducted	EN 61000-4-6	All ports	10 V/m, (crit A) (0.15 – 80 MHz)
Radiated emission	EN 55022	Enclosure	Class B
Conducted emission	EN 55022	AC power ports	Class B
	EN 55022	Ethernet ports	Class B
Temperature		Operating	–20 to +60°C (–30 to +70°C restricted operation)
		Storage & Transport	–40 to +85°C
Humidity		Operating	0 to 90% relative humidity non condensing.
		Storage & Transport	0 to 90% relative humidity non condensing.
Altitude		Operating	2000 m / 70 kPa
Service life		Operating	10 year
Dimension W x H x D			103 x 32 x 156 mm
Weight			0.30 kg
Degree of protection	IEC 529	Enclosure	IP 40
Cooling			Convection
Mounting			Horizontal on 35 mm DIN-rail

## Description

### Wireless 3G Router

The MRD-310 is a robust 3G router designed to provide remote connectivity across wireless networks. The unit features an onboard two port switch and a serial port providing the unit with versatile connection options. Together with the rugged enclosure, DIN-rail mounting and an operating voltage range spanning from 10 VDC to 60 VDC, the unit is designed for industrial applications in harsh environments. .

### Connectivity

The MRD-310 supports a wide variety of wireless standards, GSM, GPRS, 3G UMTS, HSDPA, and HSUPA, thus providing connectivity in as many applications as possible. Using High Speed Uplink Packet Access (HSUPA) the uplink capacity is 2 Mbit/s, together with the 7.2 Mbit/s downlink data making the unit suitable for even high data rate applications. With the built-in two port 10/100 Ethernet switch and the RS-232 port the MRD-310 easily allows devices to seamlessly connect over a vast geographical distance. Typical applications include video surveillance, SCADA/DNP3 telemetry systems and remote access to machines and devices.

To extend the life of legacy equipment there are a number of tools included in the product that will ensure connectivity with PLCs and other RS-232-based devices. The unit supports both packet and circuit switched mode, Serial to IP conversion, Modbus Gateway, DNP3 Level 1 Outstation, and Dial-Up modem emulation.

### Securely connect everywhere using a Virtual Private Network (VPN)

VPNs creates secure tunnels over insecure networks, such as the Internet. With the straightforward on board web interface, setting up a VPN tunnel, running between sites, is easy. The unit supports IPSec, SSL, PPTP and L2TP encryption and certificate management to secure the tunnel.

- ⌘ Tri-Band UMTS/HSDPA/HSUPA: 900/2100 MHz
- ⌘ Quad-Band GSM/GPRS/EDGE: 850/900/1800/1900 MHz
- ⌘ HSUPA/HSDPA downlink data rates of up to 7.2 Mbit/s, uplink data rates currently at 2 Mbit/s
- ⌘ Operating voltage range of 10 VDC – 60 VDC
- ⌘ Two 10/100 Ethernet switch ports with a built-in DHCP server
- ⌘ Single RS-232 port
- ⌘ Stateful packet inspection Firewall
- ⌘ Virtual Private Network (VPN) with IPSec, SSL, PPTP or L2TP encryption
- ⌘ Web and SNMP based configuration

## Interface specifications

Power	
Rated voltage	10 to 60 VDC
Operating voltage	10 to 60 VDC
Rated current (Max)	800 mA
Inrush current	1.0 A
Polarity	Polarity dependant, reverse polarity protection
Connection	Detachable screw terminal
Connector size	0.2 – 2.5 mm <sup>2</sup> (AWG 24-12)
Shielded cable	Not required

RS-232	
Electrical specification	EIA/TIA-232
Data rate	300 bit/s – 230400 bit/s
Data format	Data bits: 5, 6, 7 or 8 Stop bits: 1 or 2 Parity: None, Odd or Even Flow control: None, Software, Hardware or Both
Protocol	Transparent, DNP3, Modbus, and Modem emulation
Retiming	Yes
Transmission range	≤ 3 m
Connection	9-pin D-sub female (DCE) and 9-pin D-sub male (DTE)
Shielded cable	Not required

Antenna	
Frequency bands	850 MHz – 2100 MHz
Connection	SMA

SIM	
Electrical specification	UICC/SIM 3V and 1.8 V

Ethernet	
Electrical specification	IEEE std 802.3 2000 Edition
Data rate	10 Mbit/s, 100 Mbit/s, manual or auto
Duplex	Full or half
Transmission range	100 m / 328 ft
Connection	RJ-45

# Connections

## Ethernet TX Connections (RJ-45 connector) LAN1-2

Position	Direction	Description
1	In/Out	TD+
2	In/Out	TD-
3	In/Out	RD+
4	-	Not Connected
5	-	Not Connected
6	In/Out	RD-
7	-	Not Connected
8	-	Not Connected

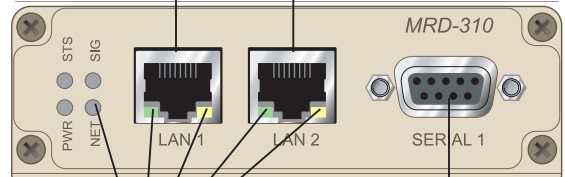

Led indicators  
(for details, see next page)

## Modem Serial Port (DCE Female)

Position	Name	Direction	Description
1	DCD	Out	Data Carrier Detect
2	RxD	Out	Receive Data
3	TxD	In	Transmit Data
4	DTR	In	Data Terminal Ready
5	SG	-	Signal Ground
6	DSR	Out	Data Set Ready
7	RTS	IN	Request to Send
8	CTS	Out	Clear to Send
9	RI	Out	Ring Indicator

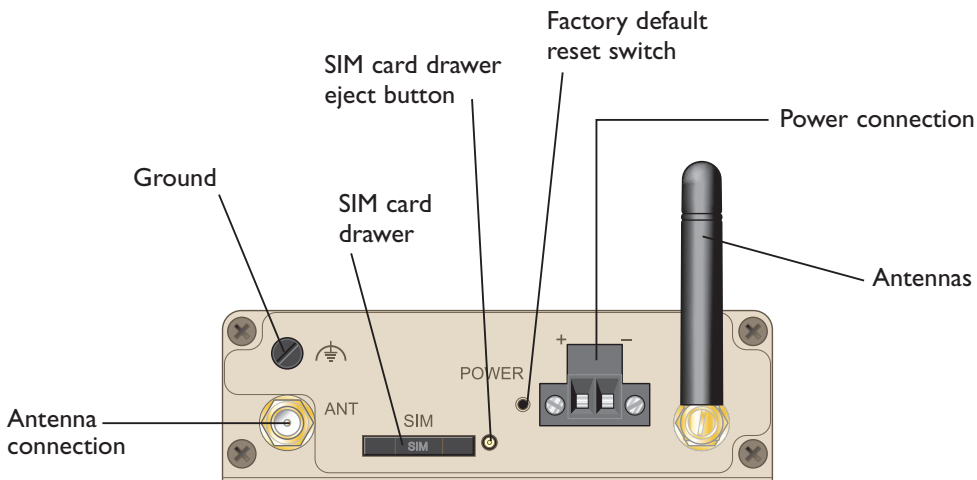
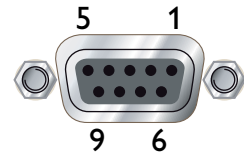

## LED indicators

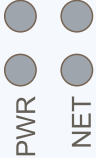
LED	Status	Description	
Power PWR	OFF ON (green)	No power Unit ready	STS SIG
Network indicator NET	OFF Flashing (green) ON (green)	Not ready Searching for network Locked to network	
Signal strength SIG	Flashing (green) Flashing (green) then red Flashing (red) ON (red)	Indication of received signal strength Network connection fault SIM card not present or faulty RF circuitry initialising or network registration fault	
Status STS	ON (red) Flashing (red) ON (green)	<b>Boot-up behaviour</b>	<b>Normal operation</b>
		No Fault No Fault N/A	Fault Fault No Fault

### Power Indicator

The power indicator will light green when power is applied. If the indicator does not light when power is applied then check the power supply connections.

### Network Indicator

The network indicator reports the status of the connection to the network. When powered up the indicator will be off, the indicator will then flash green whilst the unit searches for a network, once connected to the network the indicator will light green.

### Status Indicator

The status indicator reports the health of the unit. In normal operation the indicator will be green, if a fault is detected either at boot-up or during normal operation the indicator will light red. When the unit is first switched on or is reset the indicator will first light red, then flash red in sequence with the Signal Strength Indicator, this is normal behaviour during boot-up and does not indicate a fault.

## **Signal Strength Indicator**

The Signal Strength Indicator reports the level of the received RF signal as well as any network connection faults that occur. The signal strength is indicated by the number of green flashes of the indicator within an indicator period. Each indicator green flash will be followed by a short off time, an extended off time indicates the end of the indicator period. So an indicator period starts with a green flash followed by up to 5 additional flashes, then an extended off time, the cycle will then repeat. The maximum number of flashes in an indicator period is 6.

The indicator may be red during the extended off time following the green flashes, this indicates a network connection fault. The indicator will flash red if a SIM card is not present and will be solid red if the RF circuitry is restarting, network registration has failed or the RF signal level is too low for a connection.

When the unit is first switched on, or is reset the indicator will first light red, then flash red in sequence with the Status Indicator, this is normal behaviour during boot-up and does not indicate a fault.

# Getting started

## Installing the SIM Card

The SIM card is accessed from the rear of the unit.

- ⌘ To eject the SIM card drawer press the SIM card eject button using a suitable tool and remove the drawer, refer to figure 1 for the location of the SIM card eject button.
- ⌘ Insert the SIM card into the SIM card drawer with the contacts facing up, let chambered corners align.
- ⌘ Slid the drawer back into the unit ensuring that it locks into place.

**Note:** Before removing or inserting the SIM card, ensure that the power has been turned off and the power connector has been removed from the MRD-310.

Figure 1

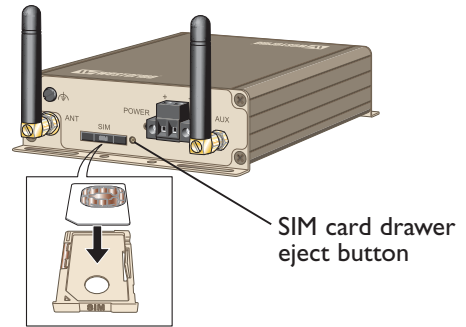

## Connecting the Antenna

The antenna connector is an SMA, an antenna may be connected directly to this connector, ensure that the connecting nut is done up tightly in order to make a good connection.

## Connect the Power Supply

The MRD-310 requires a DC power source in the voltage range of 10 to 60 VDC. The unit is designed to self protect from permanent damage if the voltage exceeds 60 VDC or if reverse polarity is applied. The modem may need to be returned for service if this occurs. The modem can also be damaged if there is any potential difference between the chassis-ground, RS-232 signal ground, power (-) input, or antenna shield. Before connecting any wiring, ensure all components are earthed to a common ground point. An external isolator will be required if a positive earth power supply is used.

## Ethernet

The Ethernet ports are on the front of the unit and are marked LAN 1 and LAN 2, each port has a LED indicating the connection speed and a LED indicating activity as shown in figure 2. Both ports are capable of auto-negotiation, meaning cross-over cables are not required. The Ethernet ports are switched, allowing more than one Ethernet device to be connected to the unit at one time.

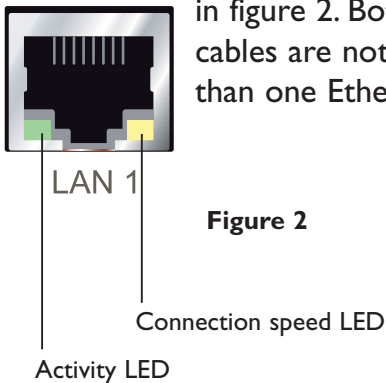

## Factory Default Reset Switch

The reset switch is used to restore the configuration of the MRD-310 to factory default settings. The switch is accessed through a small hole on the rear of the unit adjacent to the power connector, refer to figure 3.

### To reset the configuration:

- Power down the unit.
- Using a suitable tool depress the reset switch.
- Power up the unit ensuring the switch remains depressed for approximately 5 seconds after power is applied.
- The modem will now re-boot as normal with the factory default settings.

**Note:** Using the Factory Default Reset Switch will erase all existing configuration settings and restore the factory default settings. This includes the network connection profile settings APN, user name and password.

Figure 3

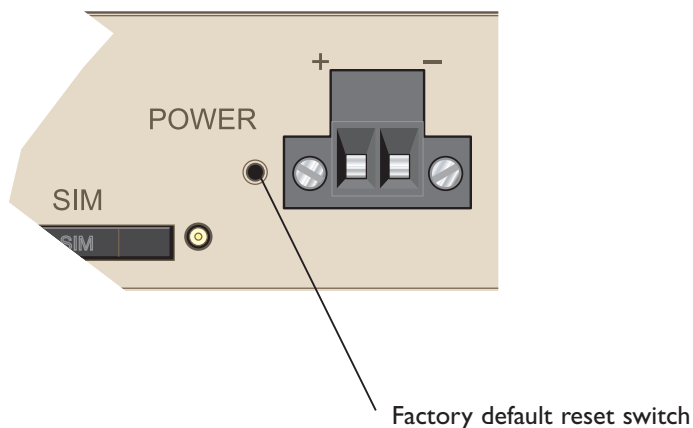

# Configuration

## Accessing and Using the Web Interface

All configuration of the MRD-310 is performed via the web interface. In order to view the web pages a computer with a fixed IP address, on the same sub-net as the MRD-310, will need to be connected to one of the LAN ports.

The default IP settings of the MRD-310 are:

- IP Address: 192.168.2.200
- Netmask: 255.255.255.0

The recommended IP settings for the PC used to configure the MRD-310 Modem/Router:

- IP Address: 192.168.2.100
- Netmask: 255.255.255.0
- Default Gateway: 192.168.2.200
- Primary DNS: 192.168.2.200

**Note:** Although it is possible to connect the MRD-310 directly to a Local Area Network (LAN) it is recommend that the network configuration as described in this section is performed prior to doing so. The DHCP server of the unit is by default disabled.

## Windows PC Network Settings

The following describes how to configure the network settings of a Windows XP PC so that it can access the MRD-310.

**Note:** This procedure will change the network settings of the Windows PC, if the PC is connected to a network the connection should be removed before performing the changes. To restore the network settings of the PC record the current settings at Step 6 in the following procedure, then when the MRD-310 has been configured following the procedure again and use the recorded values at Step 6.

1. Open the Control Panel by selecting Start > Control Panel.
2. Double click the Network Connections icon.
3. Double click the Network icon.
4. The Local Area Connection Status dialog box will be displayed, click the Properties button.
5. The Local Area Connection Properties dialog box, as shown in figure 4, will be displayed  
Click on Internet Protocol (TCP/IP) to highlight it and then click the Properties button.

Figure 4

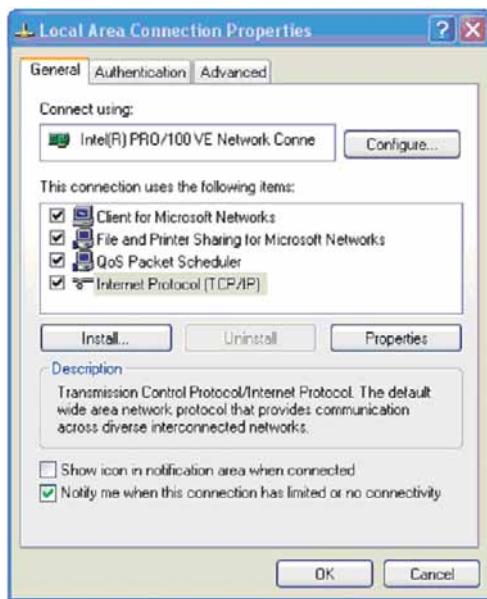

6. The Internet Protocol (TCP/IP) Properties dialog box, change the settings to match those shown in figure 5, and then click "OK."

Figure 5

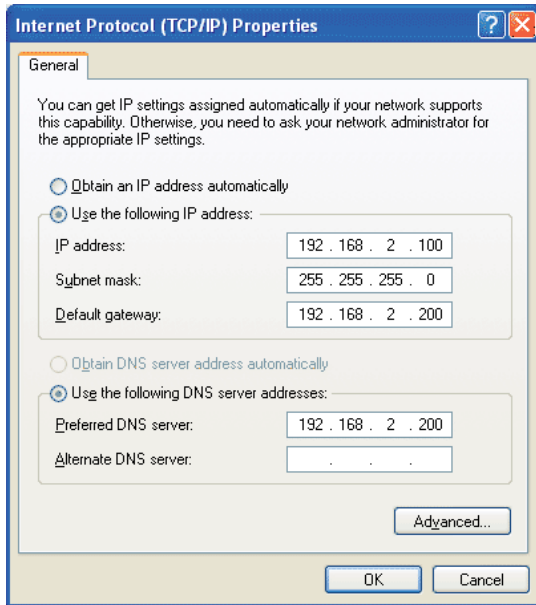

**Note:** If a web browser was open prior to making the network changes, then it will need to be closed and re-started before attempting to connect to the MRD-310.

### Accessing the MRD-310

- Open a web browser on the PC and browse to <http://192.168.2.200> (the default MRD-310, IP address) .
- A login box will popup. If the box fails to display, re-check the cable connections to the unit and the IP address settings of the PC.

Enter the following login details:

- User Name: admin
- Password: westermo

- The Status summary page will be displayed, it will be similar to figure 6.

Figure 6

System	
Power On Self Test	Passed
Temperature (°C)	now: 38.00, min: 38.00, max: 38.25
Uptime	00:03:52
Wireless	
Network Status	Fault
Connection Status	Fault
Network	
LAN	No Fault
Services	
DHCP Server	Disabled
VPN	Disabled
Serial Server	No Fault

**Note:** If the unit is not yet configured it is likely that the Network Status and Connection Status will indicate a fault condition.

## Basic Configuration

The three sections below detail the steps needed to configure the MRD-310 for basic packet mode functionality. For details on how to configure the unit for Circuit Switched mode and for more advanced configuration refer to the Advanced Configuration section of the Reference Guide.

### Configure the 3G Wireless interface

To access the configuration page for the 3G Wireless interface, click on Wireless. The Basic Wireless configuration page will be displayed as shown in figure 7.

Figure 7

Network Configuration	
Operating mode	Packet mode (HSPA/GPRS) ▾
Set SIM PIN code	<input type="text"/> <input type="button" value="Setup"/>
<input type="button" value="Reset"/>	<input type="button" value="Update"/>
Frequency Band Selection	
<input checked="" type="radio"/> All bands <input type="radio"/> UMTS only <input type="radio"/> GSM only <input type="radio"/> Custom	

## Network Configuration

The "Network Configuration" section contains the settings for the operational mode and the frequency band of the unit, the default settings will usually be adequate to connect the MRD-310 to a packet based network.

### Setting the SIM card PIN

The SIM card may have a PIN associated with it and may require the PIN to be entered before the unit can access the SIM. To set the SIM PIN click Setup. A dialog box as shown in figure 8 will be displayed.

Figure 8

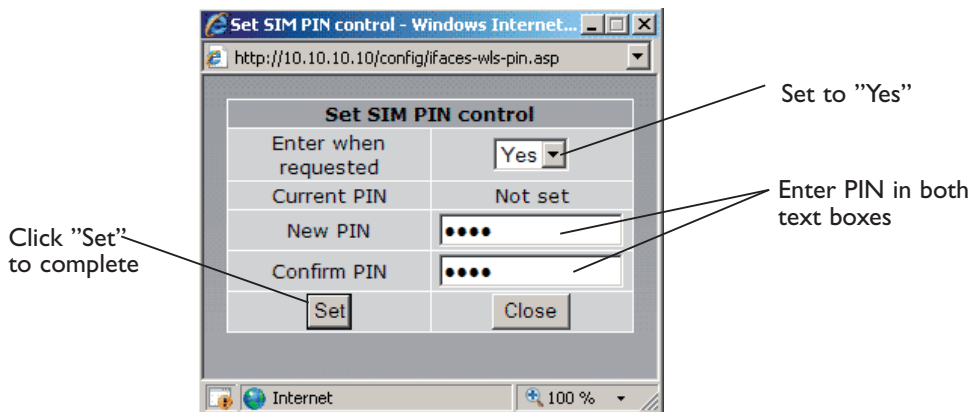

Set the field marked "Enter when requested" to "Yes" and enter the PIN in the "New PIN" and "Confirm PIN" entry boxes. Then click the "Set" button to save the PIN.

## Adding a Network Connection Profile

To access the wireless packet mode settings click on the "Packet mode" tab. The screen shown in Figure 9 will be displayed. The page shows the connection configuration details and is divided into two sections. The first section shows the current connection state selected profile. The second section lists the available profiles. A connection profile contains the settings required to connect to a provider's network. The unit allows multiple profiles to be configured to allow quick changes to the network connection settings. For most applications only one profile is required.

Figure 9

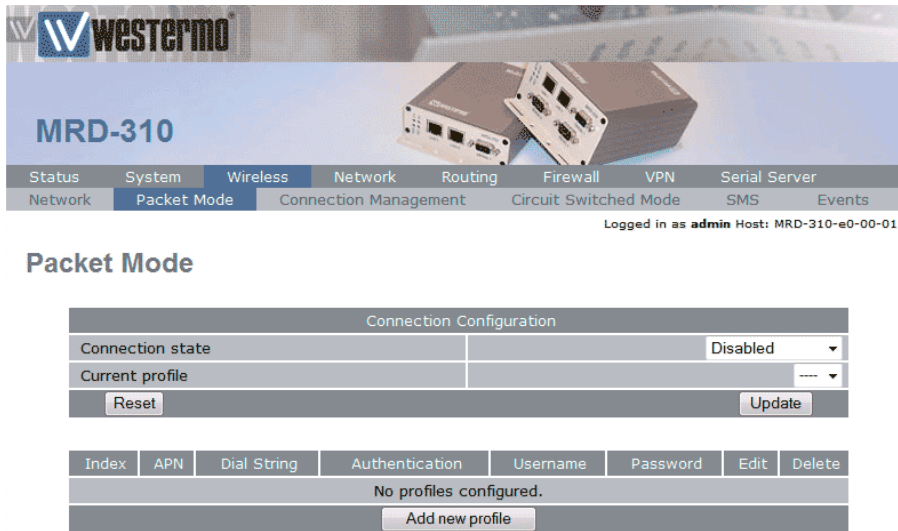

The 3G network provider will provide the items listed below which should be entered into the appropriate fields in the "Add new profile" section as shown in figure 10.

- APN (Access Point Name)
- Dial string
- Authentication (None/PAP/CHAP)
- Username
- Password

Figure 10

Westermo  
MRD-310

Status System Wireless Network Routing Firewall VPN Serial Server  
Network Packet Mode Connection Management Circuit Switched Mode SMS Events

Logged in as admin Host: MRD-310-e0-00-01

### Packet Mode

Add new profile

APN	<input type="text"/>
Dial String	<input type="text" value="*99#"/>
Authentication	<input type="text" value="None"/>
Username	<input type="text"/>
Password	<input type="text" value="Not set"/> New: <input type="checkbox"/>

- Enter APN
- Enter dial string
- Set Authentication
- Enter username
- Enter password
- Click "Update" to save profile

**Note:** In order to set a password click the check-box marked New. The password can now be entered in the text field. The password is visible as it is being typed so that it can be checked for errors prior to being set. Once set the password will no longer be visible.

**Note:** The provider may not supply a username and password if network authentication is not required. In this case set the Authentication to "None", leave the username blank and do not set a password.

Once the data has been entered click the "Update" button to add the profile. The screen will now change to show the added profile. As this is the only profile entered it will be automatically selected as the current profile and the profile entry will be shaded green to indicate that it is the selected profile.

## Enable the Wireless Connection

To complete the configuration of the wireless connection, set the "Connection state" to "Always connect" and click the "Update" button to save the changes. Once the changes have been set, the MRD-310 will initiate a connection. Normally it will take up to 30 seconds to establish a connection. Figure 11 shows the completed wireless configuration.

Figure 11



## Checking the Status of the Connection

To check the status of the connection select "Status" from the top level menu and then select "Wireless" from the second level menu. The Wireless status page will be displayed which will look similar to the one shown in figure 12. The status of the connection will change as the modem connects to the network, first it will report "Checking" then "Connecting" and finally "Connected". To see the value changing the page will need to be reloaded.

Figure 12



## Wireless

Network Status	
Network Registration	Yes
RF Level (RSSI)	13 / 30 (-87 dBm)
Provider	Telia UMTS (Location: 0018 / Cell ID: 1061)

Connection Status	
Status	Connected
Current Session Time	19:49:34
Total Session Time	19:49:34
IP Address	90.235.6.205
Packets Received	0
Bytes Received	0 B
Packets Transmitted	0
Bytes Transmitted	0 B

## Configure the LAN interface and DHCP Server

To access the configuration page for the LAN interface and DHCP Server, select "Interfaces" from the top level menu. A LAN interface screen similar to the one shown in figure 13 will be displayed.

Figure 13



### Setting the IP Address

If it is desired to change the IP address of the LAN port, follow the steps below:

- Enter the new IP address and netmask in the "Interface Configuration table".
- Click Update to set the changes. Once the changes have been set, the IP address of the MRD-310 will change. Enter the new address in the browser on the PC. It will be necessary to login again, following the procedure described in the previous section.

### Enabling DHCP

The DHCP server allows clients on the local network to be automatically allocated IP addresses from the MRD-310. The unit will also provide the clients with network settings like their default route and DNS servers. By default the DHCP server is disabled but if enabled it will be configured to serve IP addresses in the range 192.168.2.210 through 192.168.2.240, and the Default and Maximum lease times have been set to 1440 minutes. So if these values are consistent with the network that the MRD-310 is connected to, then the DHCP can be enabled by setting the Enabled field to Yes and clicking the Update button.

If the standard settings are not applicable for the connected network, then refer to figure 13 and follow the steps below, to configure the DHCP server:

- Choose a group of available IP addresses on the local network. For example, if the IP address of the MRD-310 is 192.168.2.200 with a netmask of 255.255.255.0, a group chosen could be 192.168.2.100 to 192.168.2.150. This will provide 51 addresses for clients.

Under the "DHCP Server Configuration table":

- Set the "Enabled" option to "Yes".
- Enter the first address of the group in the "Start Address box".
- Enter the last address of the group in the "End Address box".
- Enter a lease time for the "Default Lease time".
- Enter a lease time for the "Maximum Lease time".
- Click "Update" to set the changes.

Figure 14

The screenshot shows the Westermo MRD-310 web interface. The navigation menu includes 'LAN', 'DNS', and 'Diagnostics'. The DHCP Server Configuration table is as follows:

Interface Configuration	
Enabled	<input checked="" type="checkbox"/>
IP Address	192.168.2.200
Netmask	255.255.255.0
DHCP Server Configuration	
Enabled	<input type="checkbox"/>
Start address	192.168.2.210
End address	192.168.2.240
Default lease time (mins)	1440
Maximum lease time (mins)	1440
<input type="button" value="Reset"/> <input type="button" value="Update"/>	

Annotations:

- Check to enable DHCP server (points to the 'Enabled' checkbox in the DHCP Server Configuration section)
- Set the DHCP IP address range (points to the 'Start address' field)
- Set the DHCP default lease time (points to the 'Default lease time (mins)' field)
- Set the DHCP max lease time (points to the 'Maximum lease time (mins)' field)
- Click "Update" to save changes (points to the 'Update' button)

### Configure clients to use the MRD-310

The MRD-310 will act as a gateway for connections destined over the wireless interface. The default configuration will provide Network Address Translation and firewalling to protect clients on the local network.

To configure clients to use the MRD-310 as their gateway:

- If the clients have a DHCP address allocated by the MRD-310, they will have learned the necessary settings. No further configuration is needed.
- If clients have static IP addresses, set their default route and DNS server to the IP address of the MRD-310.

# Mounting

## Mounting

The MRD-310 includes integrated mounting flanges and can be attached to a panel or tray by means of screws, using the slots provided. Alternatively the MRD-310 can be DIN rail mounted, using the DIN rail mounting kit.

## Cooling

The modem should be mounted in a clean and dry location, protected from water, excessive dust, corrosive fumes, extremes of temperature and direct sunlight. Allow sufficient ventilation to ensure adequate cooling of the modem.





Westermo Teleindustri AB • SE-640 40 Stora Sundby, Sweden  
Phone +46 16 42 80 00 Fax +46 16 42 80 01  
E-mail: [info@westermo.se](mailto:info@westermo.se)  
**Westermo Web site: [www.westermo.com](http://www.westermo.com)**

### Subsidiaries

---

Westermo Data Communications AB  
Svalgången 1  
SE-724 81 Västerås  
Phone: +46 (0)16 42 80 00 • Fax: +46 (0)21 35 18 50  
[info.sverige@westermo.se](mailto:info.sverige@westermo.se)

Westermo Data Communications Ltd  
Talisman Business Centre • Duncan Road  
Park Gate, Southampton • SO31 7GA  
Phone: +44(0)1489 580-585 • Fax: +44(0)1489 580586  
E-Mail: [sales@westermo.co.uk](mailto:sales@westermo.co.uk)

Westermo Data Communications GmbH  
Goethestraße 67, 68753 Waghäusel  
Tel.: +49(0)7254-95400-0 • Fax: +49(0)7254-95400-9  
E-Mail: [info@westermo.de](mailto:info@westermo.de)

Westermo Data Communications S.A.R.L.  
9 Chemin de Chilly 91160 CHAMPLAN  
Tél : +33 1 69 10 21 00 • Fax : +33 1 69 10 21 01  
E-mail : [infos@westermo.fr](mailto:infos@westermo.fr)

Westermo Data Communications Pte Ltd  
2 Soon Wing Road #08-05  
Soon Wing Industrial Building  
Singapore 347893  
Phone +65 6743 9801 • Fax +65 6745 0670  
[sales@westermo.com.sg](mailto:sales@westermo.com.sg)

*Westermo Teleindustri AB have distributors in several countries, contact us for further information.*